

saTECH TSB-14

ARTECHE saTECH TSB test block allows the testing of the protection relay, in a safe and easy way, ensuring isolation between the relay and field elements and eliminating any risk for the user.



MAIN FEATURES

- > 14 circuits with different possible configurations (trips, current, voltages).
- > Safe for the user, who will never have access to live parts during insertion and removal operations.
- > Safe sequence of disconnection when inserting the test plug, disconnecting first the tripping circuits, to avoid unwanted operation, and later current and voltage circuits, short-circuiting CTs before opening the current circuits (Make before break sequence).
- > Safe sequential removal of the test plug, connecting first VTs and CTs, and Using a braking system allowing the relay to stabilize before connecting the tripping circuits.
- > Single Test Plug for all the different variants of Test Blocks.
- > During insertion and removal operation there will be no bounces which can cause interruption of the CT circuit.



- > Test Plug

APPLICATION

ARTECHE saTECH TSB test block includes 14 circuits, which can be accessed by removing the front cover.



Each of these circuits is connected to a separate pair of terminals at the rear of the case, and comprises a contact which is normally closed when the protection device is in normal service.

There are different types of possible circuits (trip & signals, voltage, current), and each of the circuits of the TSB test block can be configured to be of a determined type.

In case of current circuits an automatic short circuit mechanism is included to ensure the CT circuit is short-circuit before the contact in the test block opens. Two different types of short-circuits will be allowed: short-circuit of two circuits and short-circuit of four circuits, according to the application.

By the product ordering code the user will specify number of circuits of each type, the position of these circuits within the test block, and also the type of short-circuits required for the current circuits.

All the current circuits will be marked in a different color to allow easy identification, which will be visible even with the test plug inserted.

During the insertion of the test plug, the circuits are prepared for testing, in the following sequence:

1. Opening of tripping & signal circuits
2. Short-circuiting the CT's
3. Opening of current & voltage circuits

Once the test plug is connected, the protection relay is prepared for injection tests, which will not affect at all to the rest of the system, from which it has been safely isolated.

Field elements will be automatically isolated short-circuiting current circuits and opening voltage and digital circuits.

The rugged TSB-P test plug includes a mechanism to guide and facilitate the insertion on the test block ensuring the opening of all contacts at the same time, and the insertion in the correct position. Once the test plug is inserted, it is possible to block it mechanically so that not involuntary extraction could be done.

The test plug includes 28 sockets which allow the use of safe banana plugs. 14 sockets are for injection test on the protection relay, and 14 for accessing to live side. Protection side and live side are clearly marked on the test plug.

Each socket on the test plug is identified by a number which corresponds to the same numbered terminal of the test block to which the socket is connected when the test plug is inserted.

When the test plug is removed, a retention system will oblige to make this removal in the following sequence:

First step:

1. Connection of voltage & current circuits.
2. Opening the short circuit of the CTs.

Second step:

3. Connection of tripping circuits.

Before proceeding to the second step, it is necessary to act on the retention system of the test plug. This operation will give the necessary time for the values of current and voltage to stabilize after energizing transients, avoiding thus unwanted tripping due to these transients.

During insertion and removal operation there will be no bounces which can cause interruption of the CT circuit.

REAR CONNECTIONS

Maximum number of terminals to be connected on the rear side: 2.

Cable up to 4 mm² or 12 AWG.
Maximum external diameter for the ring type terminals 9 mm.

Screws type M4 with Phillips head will be supplied with the test block.

TECHNICAL SPECIFICATIONS

Technical Data		
Dielectric withstand	saTECH TSB & TSB-P IEC 60255-5	2kV incoming and outgoing circuits
		2kV open circuits, plug inserted
		5kV rms for 1 minute between all case terminals connected together and the case earth terminal
		2kV rms for 1 minute between any contact pair and either adjacent contact pair
		5kV rms for 1 minute between any alternate contact pair, provided that the intermediate contact pair is not used
Current withstand	saTECH TSB IEC 60947-7-1	All contact circuits rated at 20A continuously or 400A for 1s
	saTECH TSB-P IEC 60947-7-1	All contact circuits rated at 10A continuously or 250A for 1s
Maximum working voltage	saTECH TSB & TSB-P IEC 60255	300 volts ac or dc continuous rating
Atmospheric environment	Temperature	Storage -25°C to +70°C
		Operating -25°C to +55°C
	Humidity	IEC 60068-2-1 Cold
		IEC 60068-2-2 Dry Heat
Mechanical environment	Enclosure Protection	IEC 60529
		saTECH TSB with cover fitted IP50
		saTECH TSB without cover IP20 saTECH TSB-P fitted IP20
EMC compliance	89/336/EEC	This product has been classified as electromagnetically benign and is therefore excluded from the European Community EMC Directive



> saTECH TSB-14 Rear View

MODEL SELECTION

Test Block

Model Selection ▶▶ saTECH TSB- 14-

Options		
First open (trip and signal circuits, protection power supply circuits)	1	Contact 1-2
Second open (voltage circuits)	2	Contact 3-4
Current circuits with automatic short circuit on CT side.	A*	Contact 5-6
Current circuit with automatic short circuit on CT side, indicating the last short circuit of the CT group	B*	Contact 7-8
		Contact 9-10
		Contact 11-12
		Contact 13-14
		Contact 15-16
		Contact 17-18
		Contact 19-20
		Contact 21-22
		Contact 23-24
Mounting type: Horizontal	H	Contact 25-26
Mounting type: Vertical	V	Contact 27-28
		Mounting type

Test Plug

saTECH TSB-14-P -

Mounting type H/V

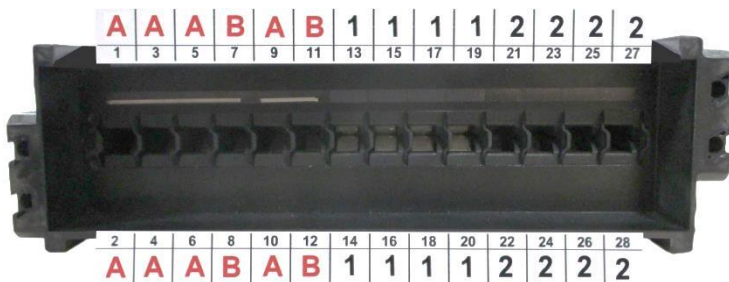

2-.Horizontal position (Reading left to right)



1-. Vertical position (reading from bottom downwards)

*Current circuits to be short-circuited must be placed together, i.e.:

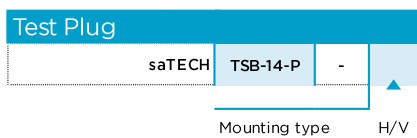
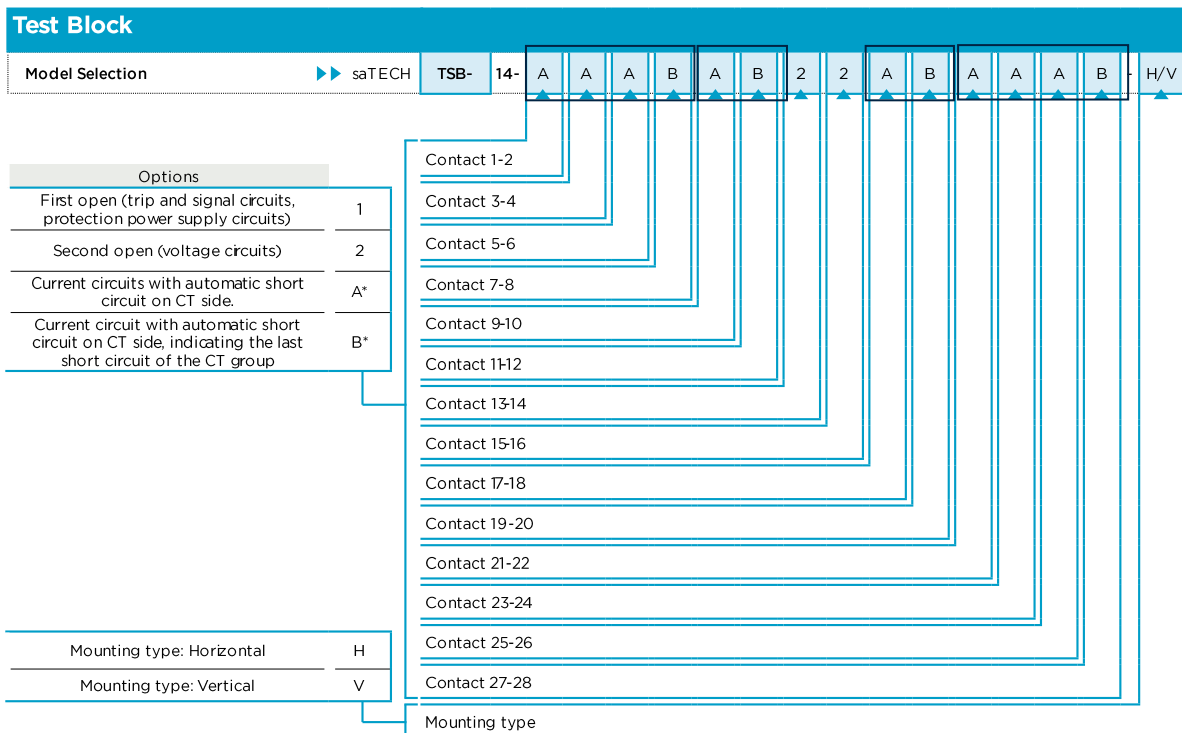
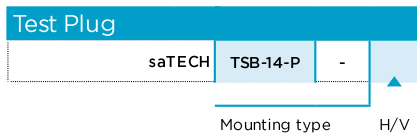
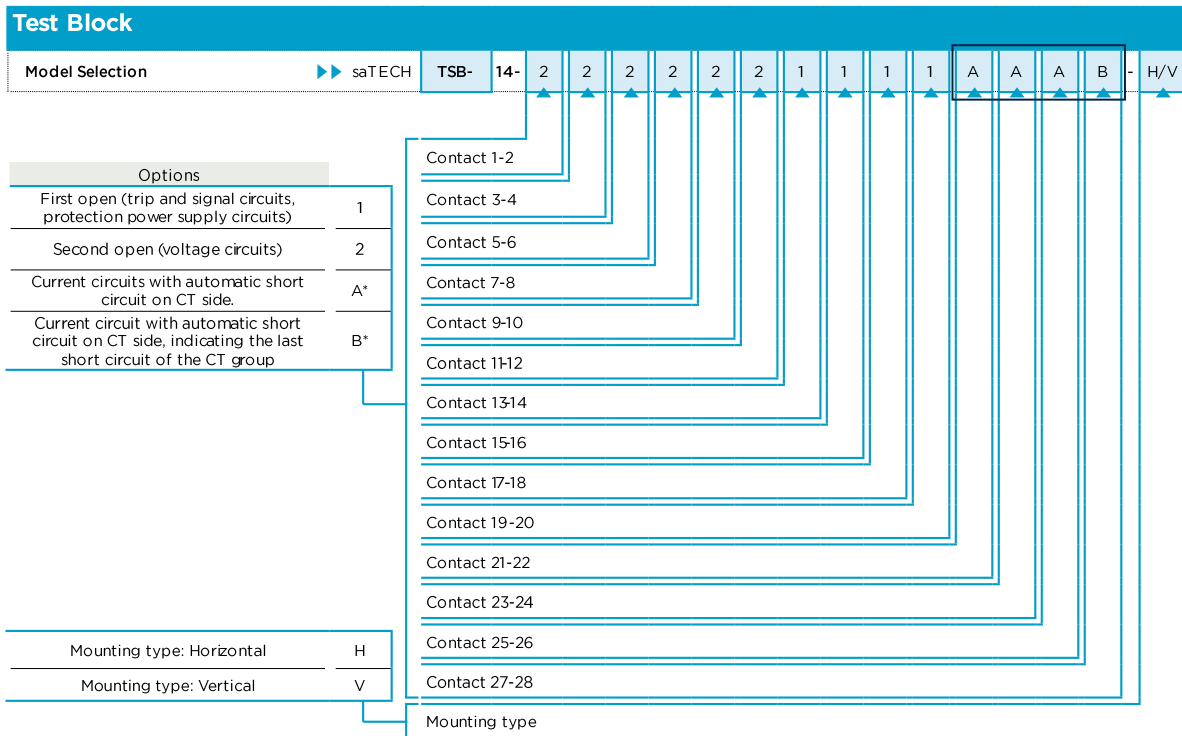

DIMENSIONS, MOUNTING & CONNECTIONS

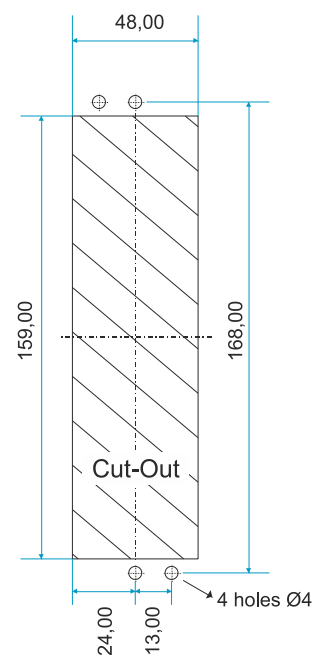
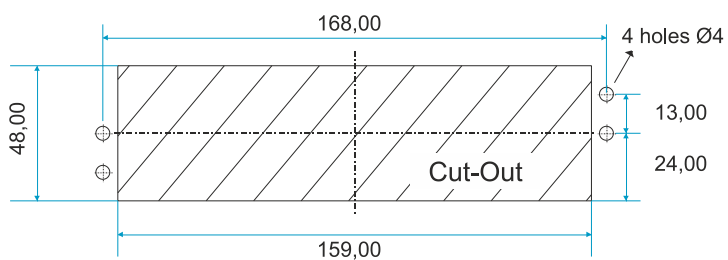
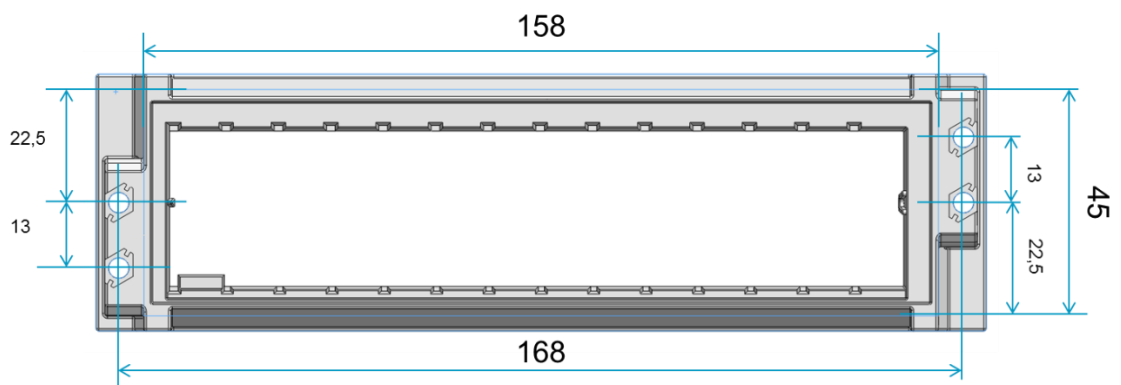
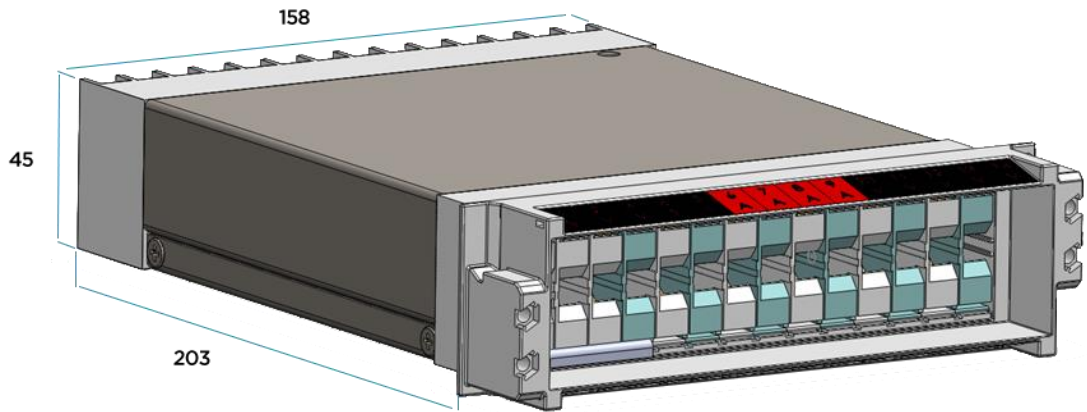

- > Suitable for panel mounting and for 19 inch rack frame.
- > Dimensions in mm.
- > Natural mounting type: Horizontal and vertical.

SAMPLE OF APPLICATION

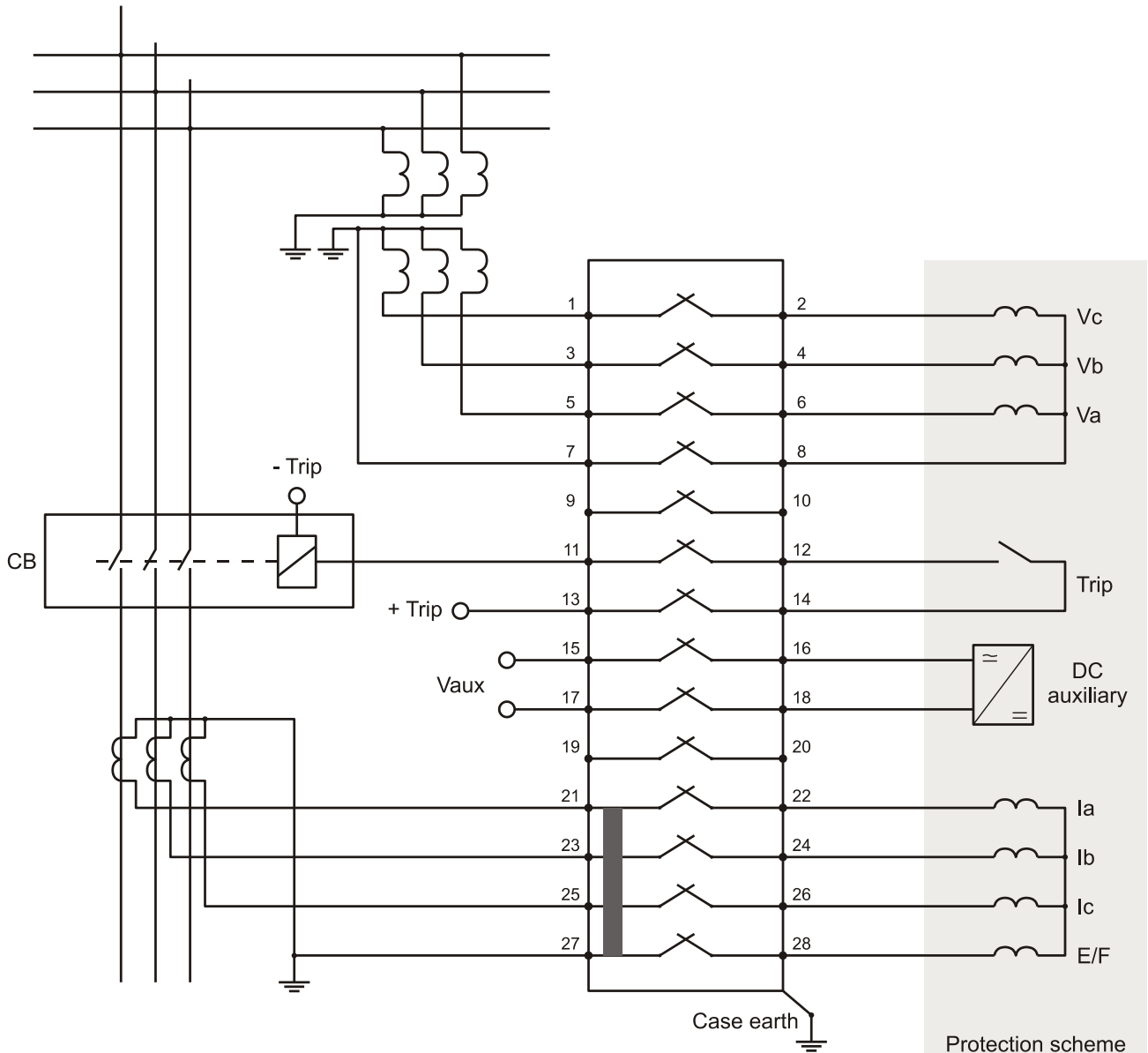

CT shunting bar for circuit isolation

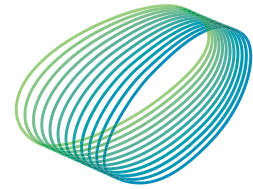

arteche

Moving together

